

Half Brick Non-isolated Buck/Boost DC-DC Converter



Features

- Efficiency up to 97%
- Wide input and output voltage ranges
- Adjustable output current limit for battery charging
- Optional active current share
- Optional digital (PMBus) interface
- Wide operating temperature range from -40°C to +100°C

Part Numbering System

NYWH	5	000	□	040	□	□	□	(□)	(□)	-	□
Series Name	Input Voltage	Output Voltage*	Enabling Logic	Rated Output Current	Pin Length	Options 1**	Options 2	Options 3	Suffix	-	Operating Temperature ***Grade (°C)
	5: 9-60V	Unit: 0.1V 000: Adjustable	P: Positive N: Negative	Unit: A 040: 40A	J: 0.220"	0: I-share & latch off 2: I-share & auto-restart 5: No I-share & latch off 7: No I-share & auto-restart	F: With flange P: W/O flange	Omit: W/O PMBus A: With PMBus	Variation code		C: -20 to +100 H: -40 to +100

* See section "Output Voltage Set Point" for details.

** When "5" or "7" is selected, the "Share" pin (Pin 5) does not exist.

*** Operating temperature is the temperature measured at the center of the baseplate.

Absolute Maximum Rating

Excessive stresses over these absolute maximum ratings can cause permanent damage to the converter. Operation should be limited to the conditions outlined under the Electrical Specification section.

Parameter	Min	Max	Unit
Input Voltage (continuous operating)	-0.5	60	V
Input Voltage (< 100ms, operating)	-	70	V
Input Voltage (continuous, non-operating)	-	80	V
Storage Temperature	-55	125	°C

Electrical Specifications

These specifications are valid over the converter's full range of input voltage, resistive load, and temperature unless noted otherwise.

Input Specifications

Parameter	Min	Typical	Max	Unit
Input Voltage	9	48	60	V
Input Current	-	-	50	A
Quiescent Input Current (typical Vin)	-	-	300	mA
Standby Input Current	-	1	2	mA
Input Turn-on Voltage Threshold	9	9.5	10	V
Input Turn-off Voltage Threshold	7	8	8.8	V
Input Voltage ON/OFF Hysteresis	-	1.5	-	V

Output Specifications

Parameter	Min	Typical	Max	Unit
Output Voltage Set Point (typical Vin; full load; Ta = 25°C)	0	24	60	V
Output Voltage Set Point Accuracy (typical Vin; full load; Ta = 25°C)	-1.5	-	+1.5	%Vo
Output Voltage Set Point Accuracy (over all conditions)	-3	-	+3	%Vo
Output Regulation: Line Regulation (full range input voltage, 1/2 full load) Load Regulation (full range load, typical Vin) Temperature (Ta = -40°C to 85 °C)	- - -	0.2 0.2 0.1	0.5 0.5 -	%Vo
Output Ripple and Noise Voltage RMS Peak-to-peak (5 Hz to 20 MHz bandwidth, typical Vin)	- - -	20 150	30 200	mVrms mVp-p
Output Current	0	-	40	A
Output Power	0	-	2,400	W
Efficiency (full load; Ta = 25°C)	24Vin, 12Vout	-	94.0	%
	48Vin, 24Vout	-	96.0	
	12Vin, 48Vout	-	93.0	

Output Specifications (Continued)

Parameter		Min	Typical	Max	Unit
Efficiency (1/2 of full load; Ta = 25°C)	24Vin, 12Vout	-	96.0	-	%
	48Vin, 24Vout	-	97.0	-	
	12Vin, 48Vout	-	94.0	-	
Output Ripple Frequency		230	250	270	kHz
External Load Capacitance (ESR>1mΩ)		100	-	10,000	μF
Startup Delay, from ON/OFF enable to Vo reaching 10% of its set point. (typical Vin; full load; Ta = 25°C)		-	10	-	ms
Startup Time Slew Rate, from Vo at 10% of its set point to Vo within its regulation band. (typical Vin; full load; Ta = 25°C)		-	0.3	-	V/ms
Output Over Current Protection Set Point/Out Current Limit Set Point		110	130	150	%
Output Over Voltage Protection Set Point/Output Voltage Set Point		115	125	135	%
Output Voltage Adjustable Range		0	-	60	V
Dynamic Response (Ta = 25°C; load transient 0.1A/μs)					
Load steps from 50% to 75% of full load (24Vin/12Vout):					
Peak deviation			300		mV
Settling time (within 10% band of Vo deviation)			1		ms
Load steps from 50% to 75% of full load (48Vin/24Vout):					
Peak deviation			500		mV
Settling time (within 10% band of Vo deviation)			1		ms
Load steps from 50% to 75% of full load (12Vin/48Vout):					
Peak deviation			800		mV
Settling time (within 10% band of Vo deviation)			1		ms
Load step from 75% to 50% of full load (24Vin/12Vout):					
Peak deviation			300		mV
Settling time (within 10% band of Vo deviation)			1		ms
Load step from 75% to 50% of full load (48Vin/24Vout):					
Peak deviation			500		mV
Settling time (within 10% band of Vo deviation)			1		ms
Load step from 75% to 50% of full load (12Vin/48Vout):					
Peak deviation			800		mV
Settling time (within 10% band of Vo deviation)			1		ms

General Specifications

Parameter		Min	Typical	Max	Unit
Remote Enable					
Logic Low:					
ON/OFF Voltage		0	-	1.2	V
ON/OFF Current (sink)		-	-	1.0	mA
Logic High:					
ON/OFF Voltage		3.5	-	20	V
ON/OFF Current (leakage)		-	-	50	μA
Isolation Voltage (Input/Output-Baseplate)		-	-	2,250	Vdc
Calculated MTBF (Telecordia SR-332, 2011, Issue 3, full load, 40°C, 60% upper confidence level, typical Vin)		-	7.78	-	10 ⁶ hour

Feature Descriptions

NYWH5 is a series of non-isolated buck/boost (step down and step-up) power converters.

When operating in buck mode ($V_{in} > V_o$), the maximum output current can be set to 40A, thus the maximum available output power is the product of 40A and the output voltage.

When operating in boost mode ($V_{in} < V_o$), the maximum input current is limited to 40A, the maximum output power is therefore the product of 40A input current, the input voltage and the conversion efficiency. For given input voltages, the output V-I characteristics are constant power curves as shown in Figure 1 without considering the conversion efficiency. As an example, Figure 1 depicts the operating region for $V_{in}=20V$, output voltage of 40V, and the output current limit at 25A.

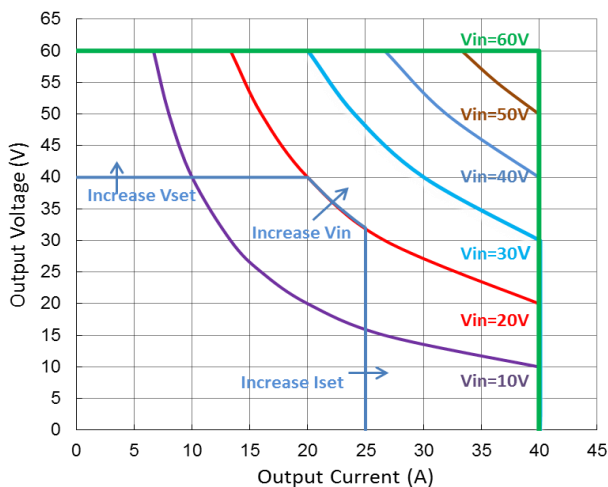

Figure 1. Typical V-I Characteristic in Boost Mode

Remote ON/OFF

The converter can be turned on and off by changing the voltage between the ON/OFF pin and $V_{in(-)}$ pin. The NYWH5 Series of converters can be ordered with positive ON/OFF logic or negative ON/OFF logic.

For the negative ON/OFF logic, the converter is ON when the ON/OFF pin is at a logic low level and OFF when the ON/OFF pin is at a logic high level. For the positive ON/OFF logic, the converter is ON when the ON/OFF pin is at a logic high level and OFF when the ON/OFF pin is at a logic low level.

With an internal pull-up circuitry, a simple external

switch between ON/OFF pin and $V_{in(-)}$ pin can turn on and turn off the converter. A few examples of ON/OFF circuits are shown in Figures 2, 3 and 4.

The logic low level is below 1.2V. The external ON/OFF switch must be capable of sinking at least 1mA current to ensure the logic-low level. When the ON/OFF switch is off, its maximum leakage current shall be less than 50 μ A to ensure the logic high level at the ON/OFF pin. For the purpose of selecting the voltage rating of this switching, ON/OFF pin internal pull-up voltage is less than 20V.

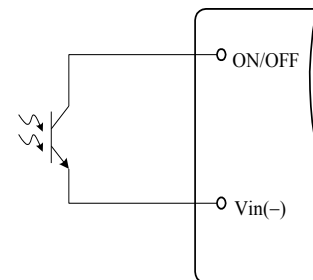

Figure 2. Opto Coupler Enable Circuit

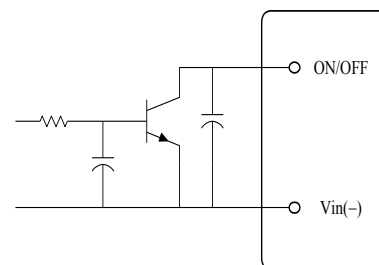

Figure 3. Open Collector Enable Circuit

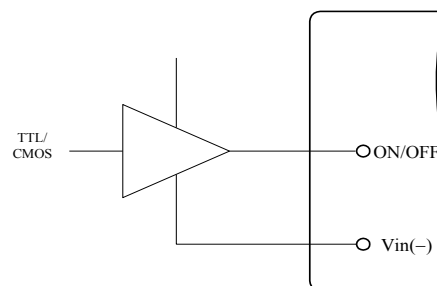

Figure 4. Direct Logic Drive

Remote SENSE

The remote SENSE pins are used to sense the voltage at a remote point where accurate voltage regulation is required.

SENSE(+) and SENSE(-) pins should be connected to the point where accurate voltage regulation is desired. The voltage between these two SENSE pins and the power converter output pins must not exceed the smaller of 0.5V or 10% of typical output voltage.

$$[V_{out(+)} - V_{out(-)}] - [SENSE(+) - SENSE(-)] < \text{MIN} \{0.5V, 10\%V_o\}$$

When remote sense is not used, the SENSE pins should be connected to their corresponding output terminals (positive and negative). If the SENSE pins are left floating, the converter will deliver an output voltage slightly higher than its specified output voltage.

Synchronization

This feature will be added soon.

Output Voltage Set Point

The output voltage is set to 0V at the factory and it can be programmed to any voltage between 0V and 60V. There are two ways to program the output voltage set point: PMBus programming or external resistor/voltage programming. When PMBus is used to program the output voltage set point, it overrides external resistor/voltage programming. When PMBus programming is not used, an external resistor or voltage can program the output voltage set point as illustrated below.

To use an external resistor to program the output voltage set point, a resistor shall be connected between Trim pin and Sense(-) pin. The circuit configuration is shown in Figure 5.

For a desired output voltage set point V_{set} , the resistance of the external programming resistor is calculated as follows:

$$R_{trim}(V_{set}) = \frac{2.366 \times V_{max} - 2.316 \times V_{set}}{0.934 \times V_{max} + 2.316 \times V_{set}} \times 10000 \ (\Omega)$$

Alternatively, the output voltage set point can be programmed with an external voltage applied to Trim pin:

$$V_{trim}(V_{set}) = 2.366 - 2.316 \left(\frac{V_{set}}{V_{max}} \right)$$

Where

V_{set} = Desired Output Voltage Set Point

V_{max} = 60V

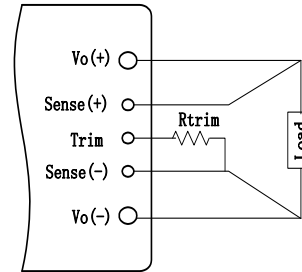

Figure 5. Circuit to Program Output Voltage Set Point

Output Current Limit Set Point

The output current limit is set to 40A at the factory and it can be programmed to any current between 0 and 40A. There are two ways to program the output current limit set point: PMBus programming or external resistor/voltage programming. When PMBus is used to program the output current limit set point, it overrides the external resistor/voltage programming. When PMBus is not used, an external resistor or voltage can program the output current limit set point as illustrated below.

To use an external resistor to program the output current limit set point, a resistor shall be connected between Iset pin and Sense(-) pin; The circuit configuration is shown in Figure 6.

For a desired output current limit set point I_{set} , the resistance of the external programming resistor is calculated as follows:

$$R_{Iset}(I_{set}) = \left(\frac{25000 I_{set}}{3.3 I_{max} - 2.5 I_{set}} \right) (\Omega)$$

Alternatively, the output current limit set point can be programmed with an external voltage applied to Iset pin:

$$V_{Iset}(I_{set}) = \left(2.5 \times \frac{I_{set}}{I_{max}} \right)$$

Where

I_{set} = Desired Output Current Set Point

I_{max} = 40A

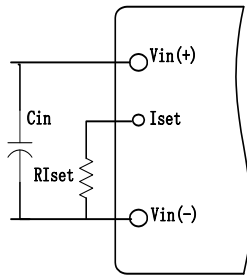

Figure 6. Circuit to Program Output Current Set Point

Active Current Share

For converters with the current share option, Share pin is used for active current share among converters operating in parallel.

To operate multiple converters in parallel, Share pin of each converter should be connected together. It is strongly advised to have a copper plane for Vin(-) on the system board to reduce the ground noise interference on the current share accuracy. The loop formed by the trace connecting Share pins and the Vin(-) plane should be minimized to avoid noise coupling into the current share circuitry.

A typical current share scheme for the NYWH5 series of converters is shown in Figure 7.

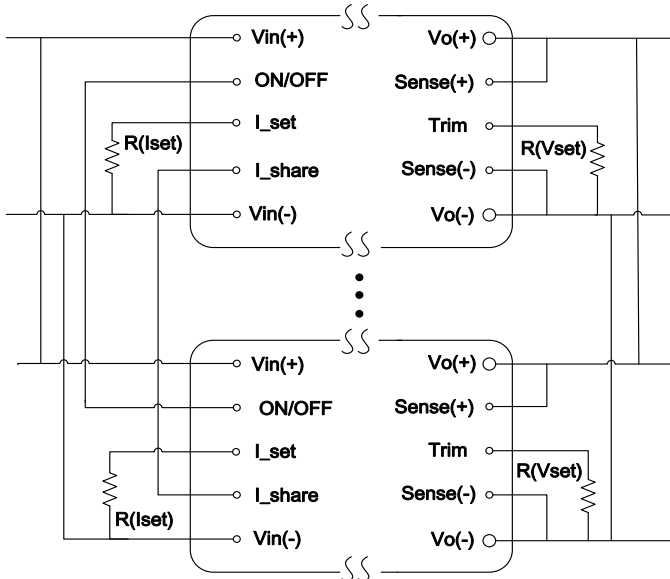

Figure 7. Circuit Configuration for Active Current Share

If parallel feature is not needed, Share pin shall be left floating.

Input Under-Voltage Lockout

This feature prevents the converter from starting until the input voltage reaches the turn-on voltage threshold, and keeps the converter running until the input voltage falls below the turn-off voltage threshold. Both turn-on and turn-off voltage thresholds are defined in the Input Specifications table. The hysteresis between these thresholds prevents oscillations.

Output Over-Current Protection (OCP)

With the latch-off version, the converter will latch off when the load current triggers the over current protection. The converter can be restarted by toggling the ON/OFF switch or recycling the input voltage.

With the auto-restart version, the converter will operate in a hiccup mode (repeatedly try to restart) until the cause of the over-current condition is cleared.

Output Over-Voltage Protection (OVP)

With the latch-off version, the converter will shut down when the output voltage rises to the over voltage protection point. The converter can be restarted by toggling the ON/OFF switch or recycling the input voltage.

With the auto-restart version, the converter will operate in a hiccup mode (repeatedly try to restart) until the cause of the over-voltage condition is cleared.

Over Temperature Protection (OTP)

With the latch-off version, the converter will shut down and latch off if an over-temperature condition is detected. The converter has a temperature sensor located at a carefully selected position, which represents the thermal condition of key components of the converter. The thermal shutdown circuit is designed to turn the converter off when the temperature at the sensor reaches 120°C. The module can be restarted by toggling the ON/OFF switch or recycling the input voltage.

With the auto-restart version, the converter will resume operation after the converter cools down.

Design Considerations

As with any DC/DC converter, the stability of the NYWH5 series of converters may be compromised if the source impedance is too high or inductive. It's desirable to keep the input source ac-impedance as low as possible. Although the converters are designed to be stable without external input capacitors, it is recommended to add 220 μ F low ESR electrolytic capacitors at the input of the converter for each 100W output power, which reduces the potential negative impact of the source impedance on the converter stability. These electrolytic capacitors should have sufficient RMS current rating over the operating temperature range.

The converter is designed to be stable without additional output capacitors. To further reduce the output voltage ripple or improve the transient response, additional output capacitors are often used which shall be a combination of ceramic capacitors and tantalum/polymer capacitors to ensure the stability of the converter.

Safety Considerations

The NYWH5 Series of converters are designed in accordance with EN 62368 Safety of Information Technology Equipment Including Electrical Equipment. The converters are designed to meet the requirements in UL 62368, Safety of Information Technology Equipment and applicable Canadian Safety Requirement, and ULc 62368. Flammability ratings of the PWB and plastic components in the converter meet 94V-0.

To protect the converter and the system, an input line fuse is highly recommended on the un-grounded input rail.

Thermal Considerations

The NYWH5 Series of converters can operate in various thermal environments. Due to the high efficiency and optimal heat distribution, these converters exhibit excellent thermal performance.

The maximum allowable output power of any power converter is usually determined by the electrical design and the maximum operating temperature of its components. The NYWH5 Series of converters have

been tested comprehensively under various conditions. For reliable operation, the baseplate temperature should not continuously exceed 100°C.

PMBus Communication

The Power Management Bus (PMBus) is an open-standard power management protocol. It is used to configure and monitor power converters and communicate with system controllers or host computers. NYWH5 Series of converters comply with PMBus revision 1.2, and support Packet Error Checking (PEC) and clock stretching function. Please refer to CAPABILITY command for the capabilities. Since NYWH5 Series of converters only support partial commands of PMBus 1.2, users should refer to Table 3 in this datasheet for supported commands. When a certain fault or warning occurs, the PMBus Alert signal will be pulled low to inform the system controller. Alert signal can be cleared through CLEAR_FAULTS command.

Users can modify some parameters of the converter while the converter is in operation, and these modifications will be lost once the converter is turned off. Users can save these modifications to the internal non-volatile memory using STORE_USER_ALL command. Users can restore the converter to the factory default configuration using RESTORE_DEFAULT_ALL command.

PMBus Address

Since multiple converters might be connected to the same bus, each should have its own address. There are two methods for configuring the PMBus address: using command MFR_PMBUS_ADDRESS_CONFIG or using address-configure resistors. The default method is address-configure resistors.

With the address-configure resistors method, two resistors should be used to connect ADDR0 pin and ADDR1 pin to Vout(-) pin as shown in Figure 8. Each resistor stands for an octonary digit (0-7), and the two resistors together configure 64 (0~63) addresses. Addresses from 64 to 127 can only be defined with MFR_PMBUS_ADDRESS_CONFIG command. The suggested resistance and the corresponding digits are listed in Table 1. The suggested resistors' accuracy is 1%. The address value can be obtained from the below equation.

PMBus Address = $8 \times \text{ADDR1} + \text{ADDR0}$

Total addresses defined in PMBus 1.2 protocol is 128 (use 7 bits). But not all of them are available to users. Addresses 0-12, 40, 44, 55, 97, 120-127 are reserved. If improper resistors are detected or the resulted address is reserved, the default address 127 is assigned. For instance, when the address-configure resistors are not connected, the active address is 127.

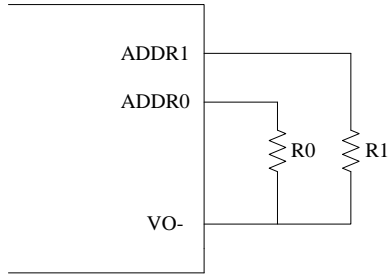

Figure 8. Address-configure Resistors

ADDR0/ADDR1	R0/R1(kΩ)
0	10
1	22
2	33
3	47
4	68
5	100
6	150
7	220

Table 1. Address Digit Values vs. Resistor Values

PMBus data Format

Different units and data formats are used in PMBus commands for usability and operational efficiency.

VOUT Linear format

For some commands that set or monitor output voltage related parameters, including VOUT_COMMAND, VOUT_MARGIN_HIGH/LOW, VOUT_MAX, READ_VOUT, POWER_GOOD_ON/OFF, etc., their active data formats are the same, and are defined with command VOUT_MODE. Among the three data formats (linear format, VID format and direct format), this NYWH5 design uses linear data format, which is renamed as VOUT Linear, and the other two data

formats are not supported. VOUT Linear is a float point data format with 16 significant binary digits. The mantissa is saved as a 16-bit unsigned integer, while the data format and the exponent are defined using VOUT_MODE command as described in Table 2. Therefore, for a certain data, only mantissa should be saved. VOUT_MODE command is not writable, and its default value is 0x17 for NYWH5 Series of converters, which means linear float point data format is used (bit7:5 is 0b000), and the exponent is -9 (bit4:0 is 0b10111, which is -9 as 5 bits two's complement). So, the actual value is as follows.

$$\text{Value} = \text{mantissa} \times 2^{-9}$$

Bit 7:5	Bit 4:0
0b000	0b10111
Mode(linear)	Exponent(-9)

Table 2. VOUT_MODE

Linear format

For other commands that set thresholds or report measurements, Linear data format is used, which is a two byte value made up of an 5 bit exponent of two's complement, and 11 bit mantissa of two's complement, as shown in Figure 9.

$$\text{Value} = \text{mantissa} \times 2^{\text{exponent}}$$

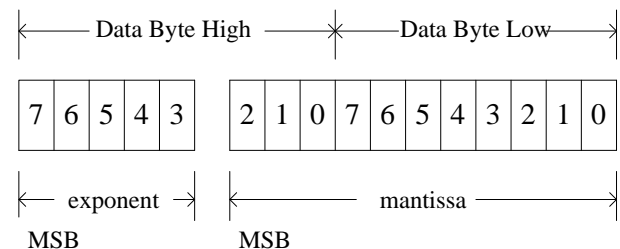

Figure 9. Linear Data Format

Bit Field format

This format is specially defined according to each command. The data is usually divided into several bit fields, and each of the bit fields is defined separately.

Byte format

The data comprise series of bytes and each byte stands for an integer number or an ASCII code and so on.

PMBus Commands

PMBus protocol revision 1.2 is based on SMBus protocol revision 2.0. So the format of PMBus commands is similar to that of SMBus commands except for some extensions. Users can refer to PMBus and SMBus protocol documents for more detailed descriptions of the commands.

The supported commands or features are described in the below table. All reserved bits or combinations of them are not used in this design. If users write any reserved bits or combinations of them, the module will not react. 'Reserved' bits or their combinations are for use in future versions and are not defined in this version of protocol.

Table 3: Supported PMBus Commands

Cmd Name	Cmd Code	Transfer Type	Data Format	Min	Default Value	Max	Data Unit	Note
Standard PMBus Commands								
OPERATION	01h	R/W byte	Bit field	-	0x00	-	-	
ON_OFF_CONFIG	02h	R/W byte	Bit field	-	0x16	-	-	
CLEAR_FAULTS	03h	Send byte	-	-	-	-	-	
WRITE_PROTECT	10h	R/W byte	Bit field	-	0x00	-	-	
RESTORE_DEFAULT_ALL	12h	Send byte	-	-	-	-	-	
STORE_USER_ALL	15h	Send byte	-	-	-	-	-	
RESTORE_USER_ALL	16h	Send byte	-	-	-	-	-	
CAPABILITY	19h	Read byte	Bit field	-	0xB0	-	-	PEC, max bus speed is 400k, SMBAlert
VOUT_MODE	20h	Read byte	Bit field	-	0x17	-	-	Only Linear Mode is supported, exp=-9
VOUT_COMMAND	21h	R/W word	VOUT linear	0.0	-	60.0	V	Active only while VOUT_SET_MODE=0
VOUT_MAX	24h	Read word	VOUT linear	-	60.0	60.0	V	
VOUT_MARGIN_HIGH	25h	R/W word	VOUT linear	0.0	60.0	60.0	V	
VOUT_MARGIN_LOW	26h	R/W word	VOUT linear	0.0	0.0	60.0	V	
VOUT_TRANSITION_RATE	27h	R/W word	Linear	0.01	1.2	3.0	mV/μs	
VIN_ON	35h	R/W word	Linear	9.0	9.5	60.0	V	
VIN_OFF	36h	R/W word	Linear	7.0	8.0	60.0	V	
VOUT_OV_FAULT_RESPONSE	41h	R/W byte	Bit field	-	0xBF	-	-	Bits[7:6], only 0b10 is supported
IOUT_OC_FAULT_RESPONSE	47h	R/W byte	Bit field	-	0xFF	-	-	Bits[7:6], only 0b11 is supported
OT_FAULT_LIMIT	4Fh	R/W word	Linear	110	125	135	°C	
OT_FAULT_RESPONSE	50h	R/W byte	Bit field	-	0xC0	-	-	Bits[7:6], only 0b11 is supported
OT_WARN_LIMIT	51h	R/W word	Linear	100	120	135	°C	
VIN_OV_FAULT_LIMIT	55h	R/W word	Linear	60.0	66.0	70.0	V	
VIN_OV_FAULT_RESPONSE	56h	R/W byte	Bit field	-	0xBF	-	-	Bits[7:6], only 0b11 and 0b10 are supported
VIN_OV_WARN_LIMIT	57h	R/W word	Linear	9.0	66.0	70.0	V	
VIN_UV_WARN_LIMIT	58h	R/W word	Linear	9.0	10.0	60.0	V	
VIN_UV_FAULT_LIMIT	59h	R/W word	Linear	8.0	9.0	66.0	V	
VIN_UV_FAULT_RESPONSE	5Ah	R/W byte	Bit field	-	0x00	-	-	Bits[7:6], only 0b00 and 0b10 are supported

Cmd Name	Cmd Code	Transfer Type	Data Format	Min	Default Value	Max	Data Unit	Note
POWER_GOOD_ON	5Eh	R/W word	VOUT linear	0.0	4.0	60.0	V	
POWER_GOOD_OFF	5Fh	R/W word	VOUT linear	0.0	3.0	60.0	V	
TON_DELAY	60h	R/W word	Linear	5.0	10.0	1000.0	ms	
TON_RISE	61h	R/W word	Linear	50.0	200.0	1000.0	ms	For output voltage set point is dynamic, this value is set by max output voltage set point value, real value can be converted into according to this parameter
TOFF_DELAY	64h	R/W word	Linear	0.0	0.0	1000.0	ms	
TOFF_FALL	65h	R/W word	Linear	4.0	200.0	1000.0	ms	For output voltage set point is dynamic, this value is set by max output voltage set point value, real value can be converted into according to this parameter
STATUS_BYTE	78h	Read byte	Bit field	-	-	-	-	
STATUS_WORD	79h	Read word	Bit field	-	-	-	-	
STATUS_VOUT	7Ah	Read byte	Bit field	-	-	-	-	
STATUS_IOUT	7Bh	Read byte	Bit field	-	-	-	-	
STATUS_INPUT	7Ch	Read byte	Bit field	-	-	-	-	
STATUS_TEMPERATURE	7Dh	Read byte	Bit field	-	-	-	-	
STATUS_CML	7Eh	Read byte	Bit field	-	-	-	-	
READ_VIN	88h	Read word	Linear	-	-	-	V	
READ_VOUT	8Bh	Read word	VOUT linear	-	-	-	V	
READ_IOUT	8Ch	Read word	Linear	-	-	-	A	
READ_TEMPERATURE_1	8Dh	Read word	Linear	-	-	-	°C	The converter's temperature
READ_DUTY_CYCLE	94h	Read word	Linear	-	-	-	%	
READ_FREQUENCY	95h	Read word	Linear	-	-	-	KHz	
PMBUS_REVISION	98h	Read byte	Bit field	-	0x42	-	-	PMBus Revision 1.2
MFR_MODEL	9Ah	Block read	Bytes	-	Factory set	-	ASCII	
MFR_VIN_MIN	A0h	Read word	Linear	-	8.4	-	V	
MFR_VIN_MAX	A1h	Read word	Linear	-	60.0	-	V	
MFR_VOUT_MIN	A4h	Read word	VOUT linear	-	0.0	-	V	
MFR_VOUT_MAX	A5h	Read word	VOUT linear	-	60.0	-	V	
MFR_TAMBIENT_MAX	A8h	Read word	Linear	-	85	-	°C	
MFR_TAMBIENT_MIN	A9h	Read word	Linear	-	-40	-	°C	
Specific Commands								
VOUT_SET_MODE	D1h	R/W byte	Bit field	-	0	-	-	0:command mode,1:external mode
IOUT_SET_MODE	D2h	R/W byte	Bit field	-	0	-	-	0:command mode,1: external mode
IOUT_COMMAND	D3h	R/W word	Linear	0.0	40.0	40.0	A	Active only while IOUT_SET_MODE=0
MFR_PMBUS_ADDRESS_CONFIG	F6h	R/W byte	Bytes	-	127	-	-	If a new PMBus address is written, it will take effect after next power up.
MFR_MULTI_PIN_CONFIG	F9h	R/W byte	Bit field	-	0x01	-	-	

Mechanical Drawing

Without flange

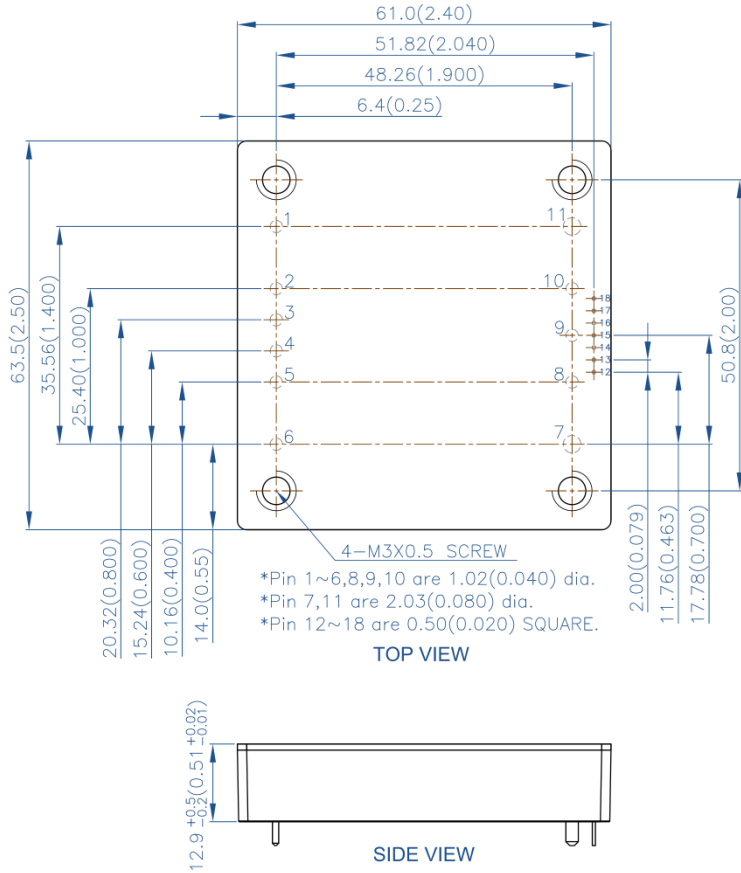

With flange

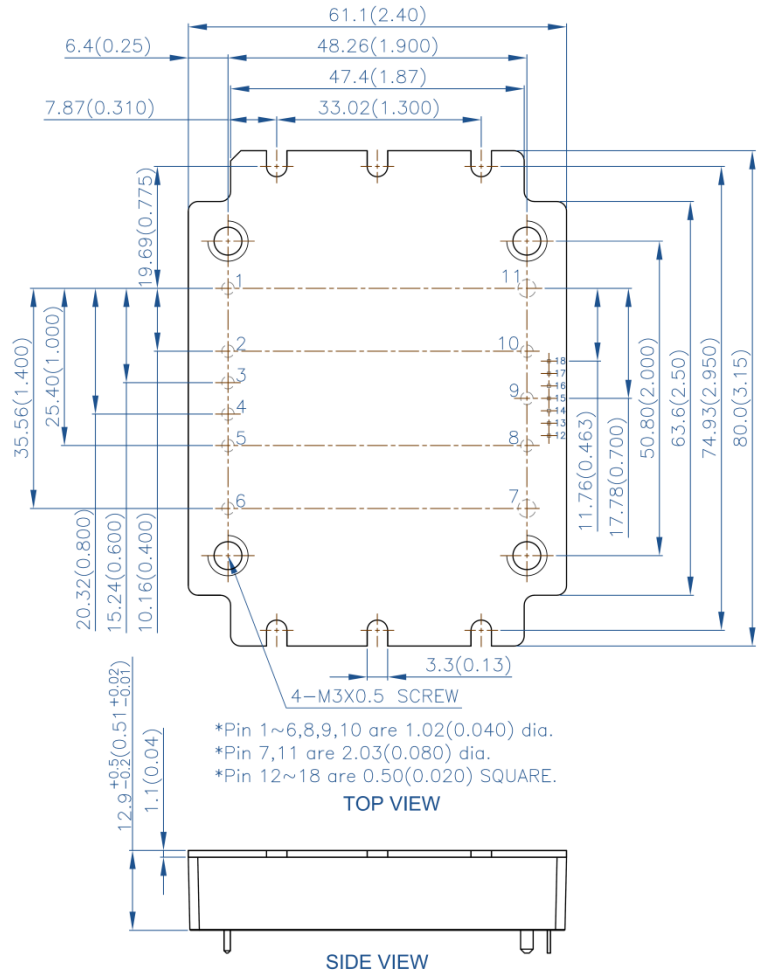

Pin	Name	Function	Pin	Name	Function
1	Vin(+)	Positive input voltage	12	PGOOD	Power good
2	ON/OFF	Remote control	13	SGND	Signal ground
3	SYNC	Synchronize the converter to an external converter	14	DATA	PMBUS_data
4	Iset	Set maximum output current	15	ALERT	PMBUS_alert
5	SHARE	Current share (optional)	16	CLK	PMBUS_clock
6	Vin(-)	Negative input voltage	17	ADDR1	The high order digital address
7	Vout(-)	Negative output voltage	18	ADDR0	The low order digital address
8	SENSE(-)	Negative remote sense	Optional: Pin 12~18		
9	TRIM	Output voltage adjustment			
10	SENSE(+)	Positive remote sense			
11	Vout(+)	Positive output voltage			

Notes:

- All dimensions in mm (inches)
Tolerances: .x ± .5 (.xx ± 0.02)
.xx ± .25 (.xxx ± 0.010)
- Input and control pins are 1.02mm (0.040") dia. with +/- 0.10mm (0.004") tolerance. The recommended diameter of the receiving hole is 1.42mm (0.056").
- Output pins are 2.03 mm (0.080") dia. with +/- 0.10mm (0.004") tolerance. The recommended diameter of the receiving hole is 2.44mm (0.096").
- Pin 12~18 are digital pins, 0.50mm (0.020") square; copper with golden flash plating.
- All pins are Copper Alloy, Gold finish with Nickel under plating.
- Weight: 152 g
- Workmanship meets or exceeds IPC-A-610 Class II.
- Torque applied on screw should not exceed 6in-lb. (0.7 Nm).
- Baseplate flatness tolerance is 0.10mm (0.004") TIR for surface.